

■	Hg (m)		■	Hg (m)	
	○	□		○	□
FEM			FEM		
CATR	55.7	54.9	CATR	60	59.2
CAF	59.6	58.8	CAF	63.5	62.8
TEF	58.8	58	TEF	58.8	58
TRF	58	57.2	TRF	58	57.2
<b>C25</b>					
CATR	47.9	47.1	CATR	56.1	55.3
CAF	59.6	58.8	CAF	55.7	54.9
TEF	58.8	58	TEF	51	50.2
TRF	58	57.2	TRF	50.2	49.4
<b>D25</b>					
CATR	43.9	43.1	CATR	48.3	47.5
CAF	43.2	42.4	CAF	51.8	51
TEF	43.2	42.4	TEF	47.1	46.3
TRF	42.4	41.6	TRF	46.3	45.5

Power Control      ASsys      ACsys      ULTRALIFT

**CE** FEM 1.001 - A4  
EN 14439 - C25 - D25

Torre/Reazioni – Masts/Reactions – Mat/Réactions – Maste/Eckdrücke – Mástil/Reacciones – Tramo/Reacções

SK1700 FEM

○ Hg=Ht-1 m  
 □ Hg=Ht-1.8 m

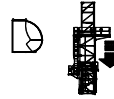
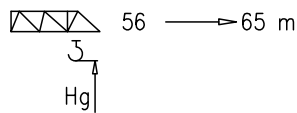

6	BCF052	2/4
5	BPF117	4/4
4	BPF039	4/4
3	ST117	2/2
2	BAF117	4/2
1	ST039	2/2

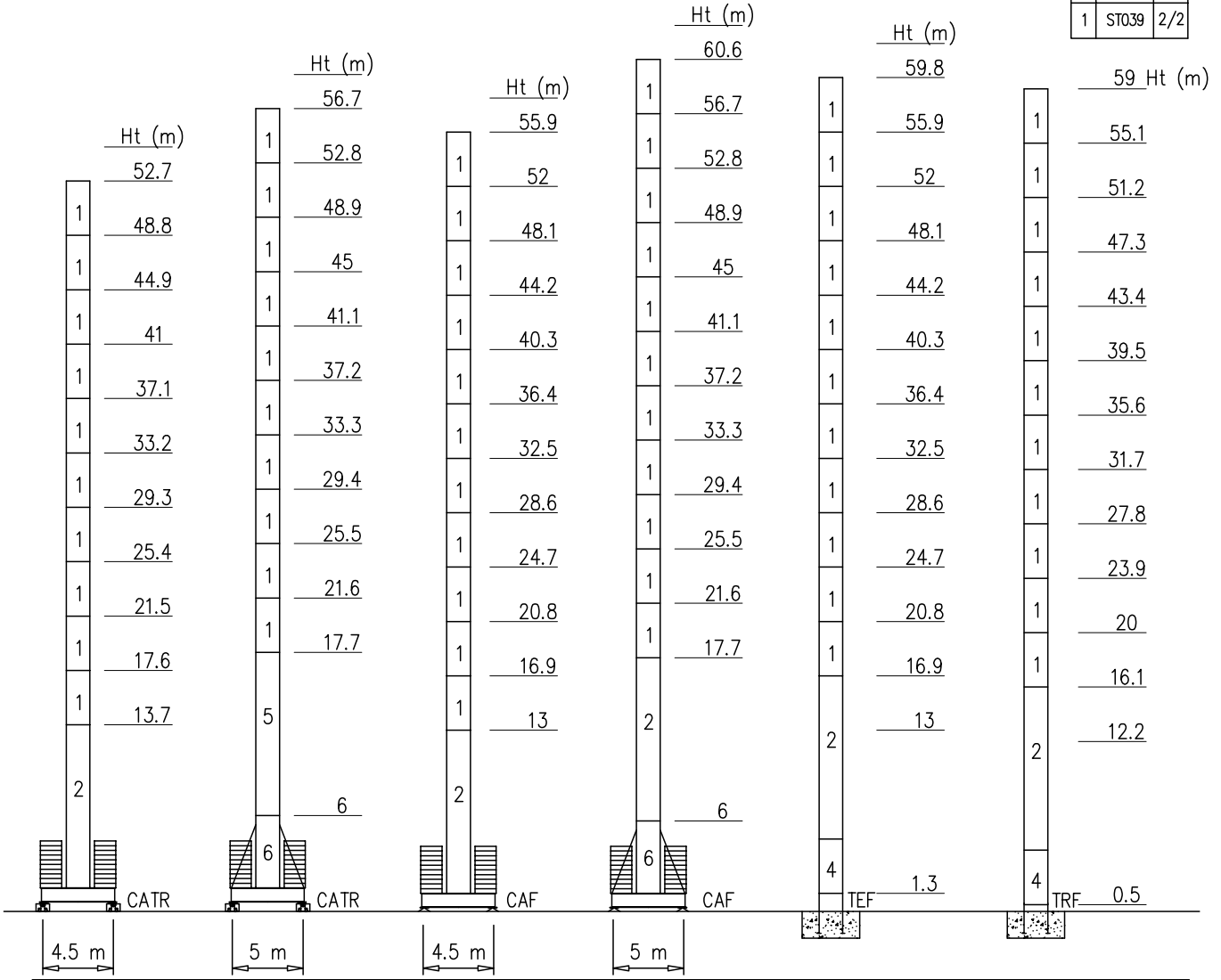

Peso zavorra – Ballast weight – Poids du lest – Ballastgewicht – Peso de lastre

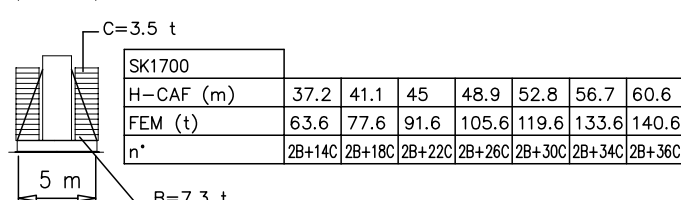
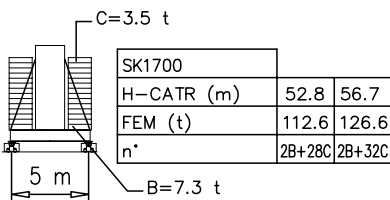
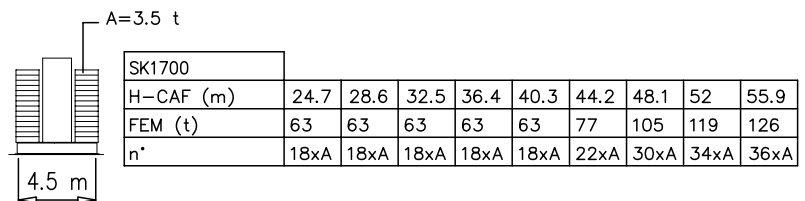
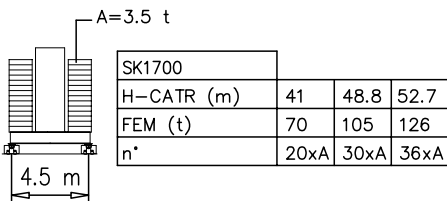

Torre/Reazioni – Masts/Reactions – Mat/Réactions – Maste/Eckdrücke – Mástil/Reacciones – Tramo/Reacções

SK1700 EN14439-C25

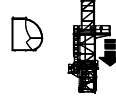
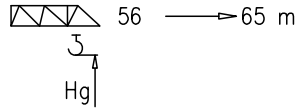

6	BCF052	2/4
5	BPF117	4/4
4	BPF039	4/4
3	ST117	2/2
2	BAF117	4/2
1	ST039	2/2

○ Hg=Ht-1 m  
 □ Hg=Ht-1.8 m

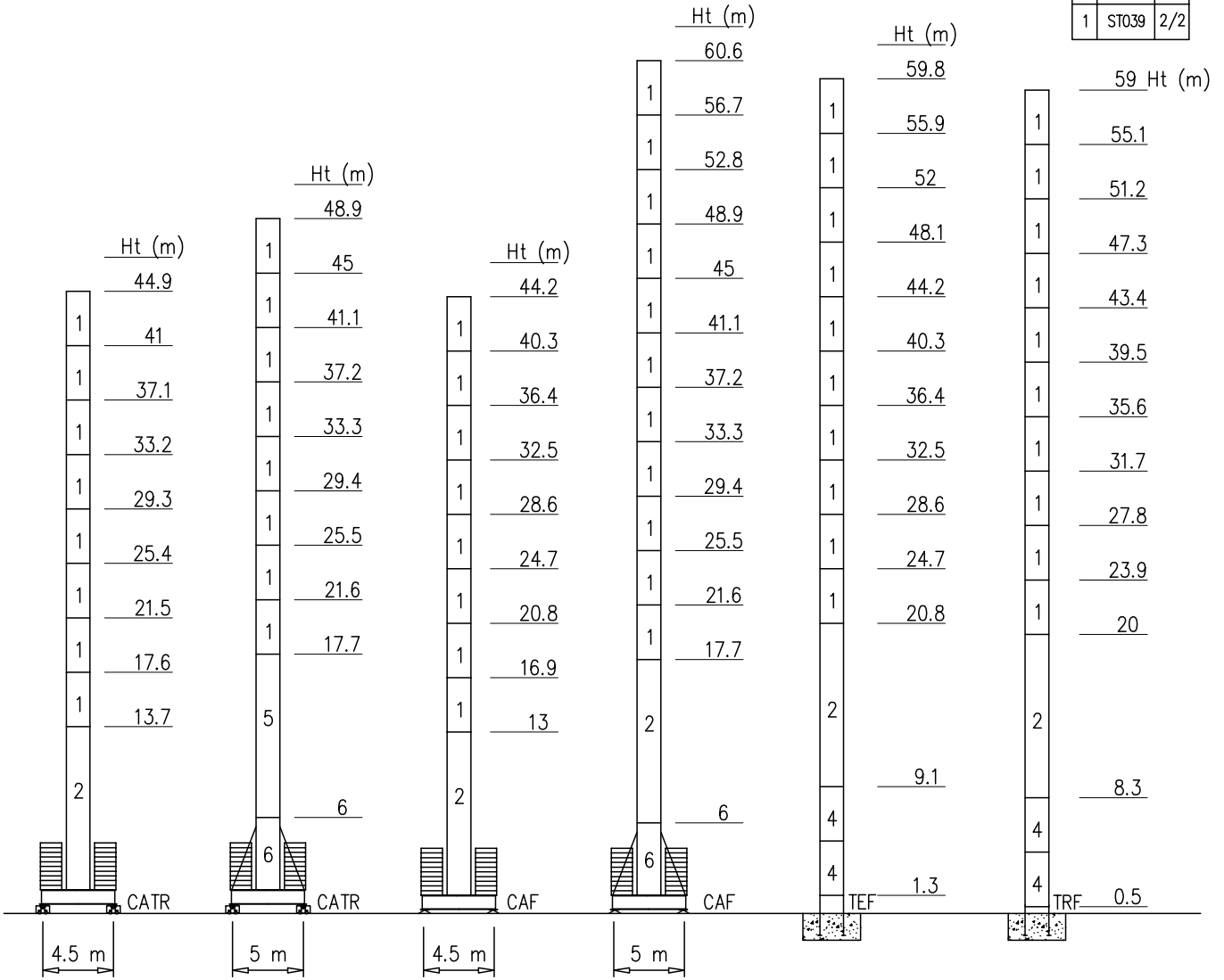

Peso zavorra – Ballast weight – Poids du lest – Ballastgewicht – Peso de lastre

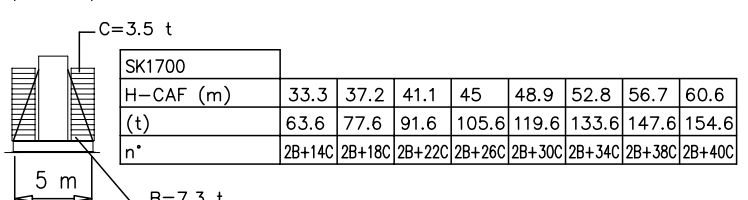
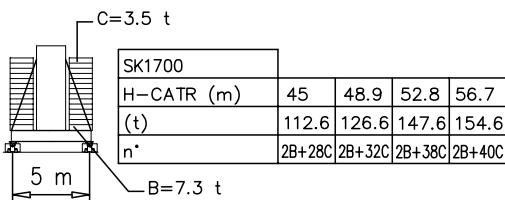
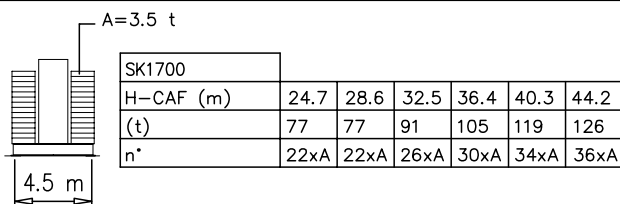
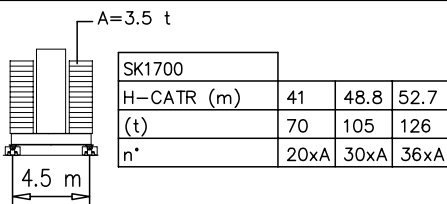

Torre/Reazioni – Masts/Reactions – Mat/Réactions – Mast/Eckdrücke – Mástil/Reacciones – Tramo/Reacções

SK1700 EN14439-D25

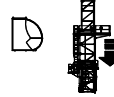
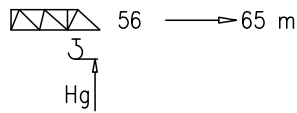

6	BCF052	2/4
5	BPF117	4/4
4	BPF039	4/4
3	ST117	2/2
2	BAF117	4/2
1	ST039	2/2

- Hg=Ht-1 m
- Hg=Ht-1.8 m

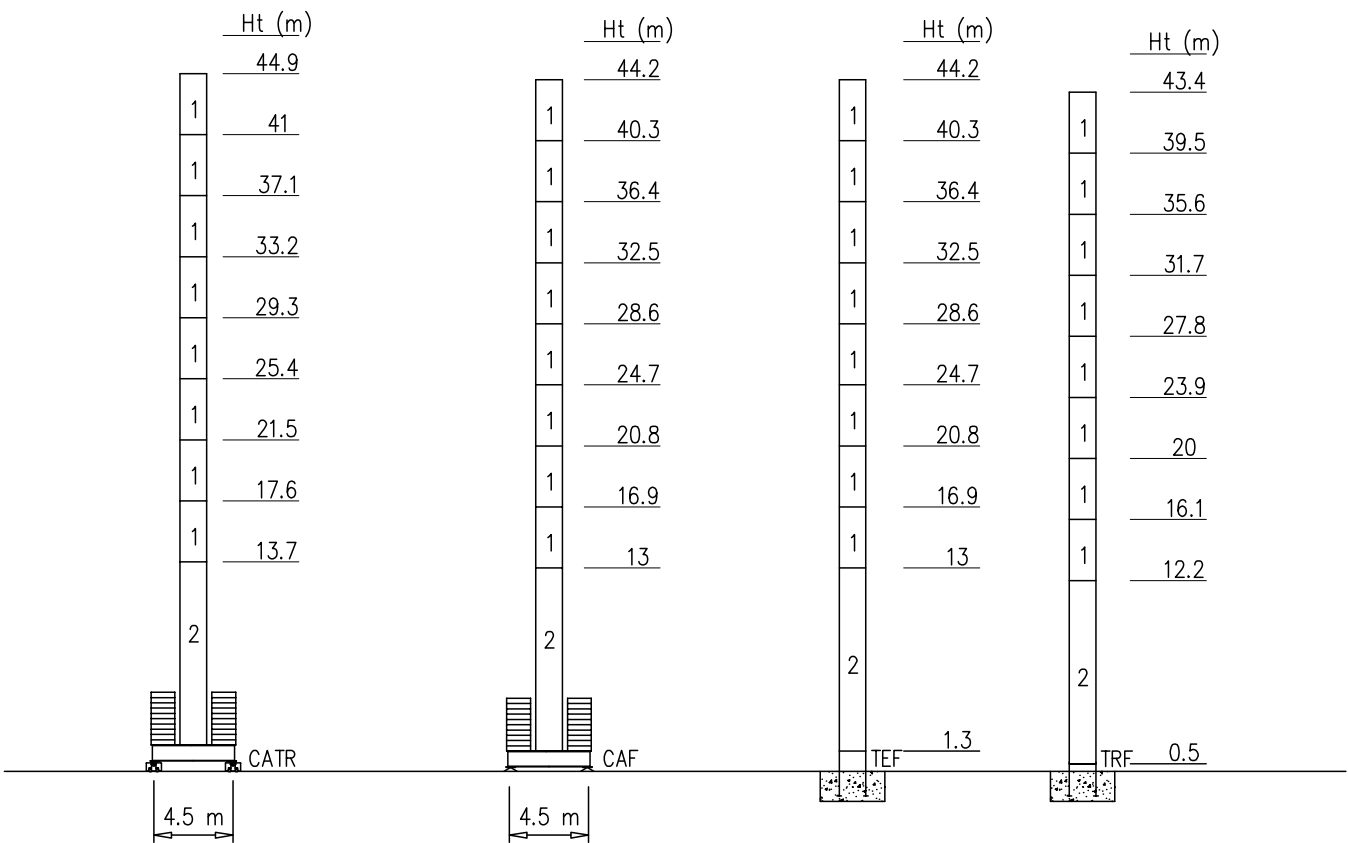

Peso zavorra – Ballast weight – Poids du lest – Ballastgewicht – Peso de lastre

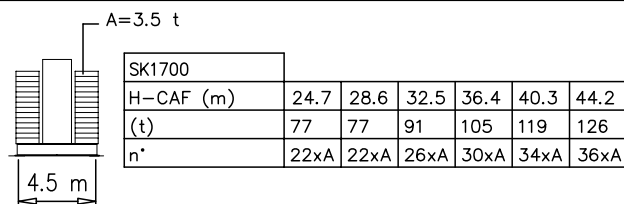
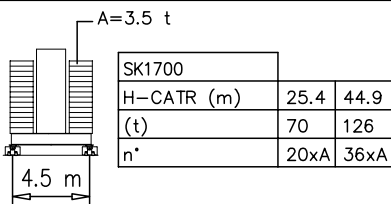



Torre/Reazioni – Masts/Reactions – Mat/Réactions – Maste/Eckdrücke – Mástil/Reacciones – Tramo/Reacções

SN2050 EN14439-C25

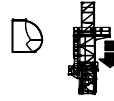
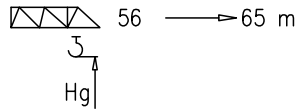

- Hg=Ht-1 m
- Hg=Ht-1.8 m

14	BCF052	2/4 M45
13	BAF052	2/4 M42
12	BPF117	4/4 M45-45
11	BNF117	4/4 M45-42
10	BOF117	4/4
9	BOF039	4/4
8	BO039	2/2
7	STR039	2/2
6	SBR117	4/2
5	SBR039	4/2
4	SB117	4/2
3	SB039	4/2
2	ST117	2/2
1	ST039	2/2

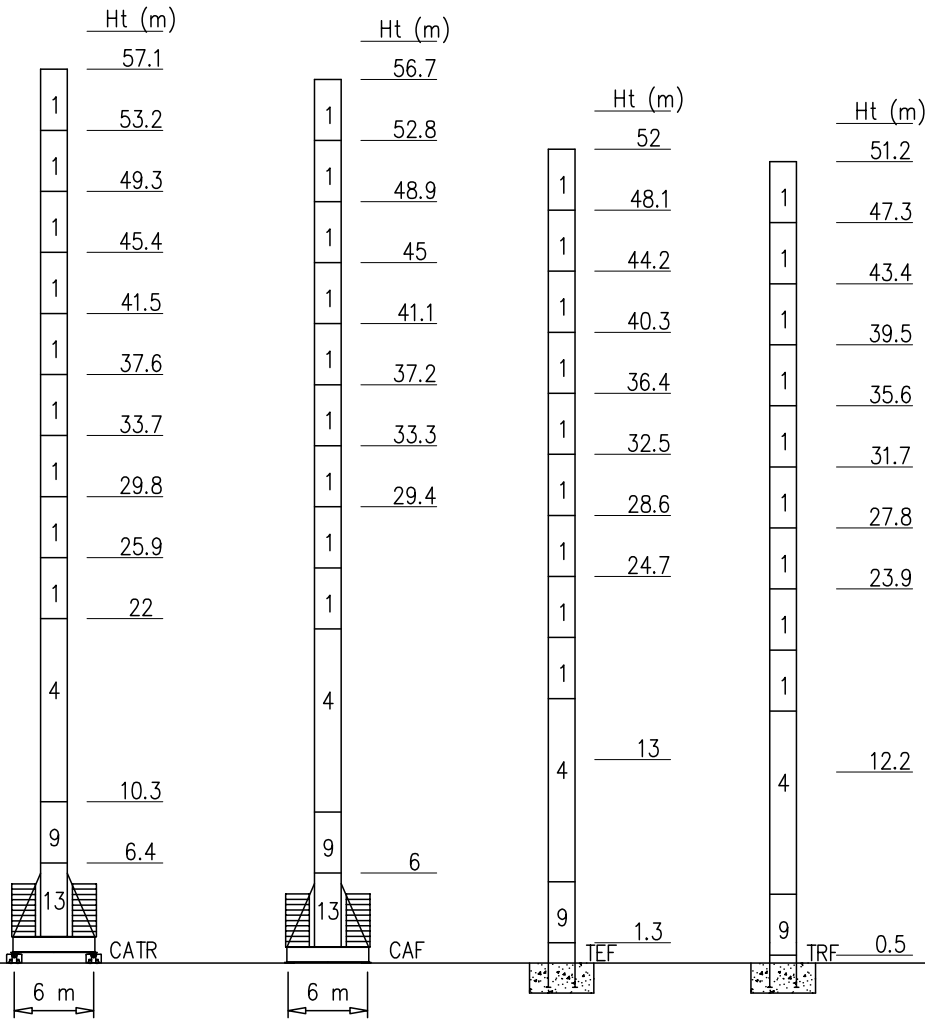

Peso zavorra – Ballast weight – Poids du lest – Ballastgewicht – Peso de lastre

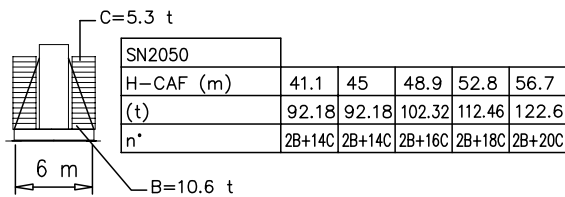
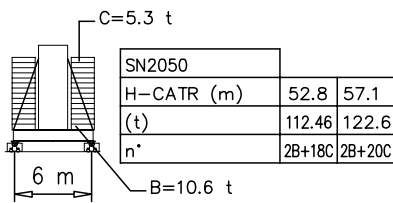

Torre/Reazioni – Masts/Reactions – Mat/Réactions – Maste/Eckdrücke – Mástil/Reacciones – Tramo/Reacções

SN2050 EN14439-D25

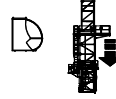
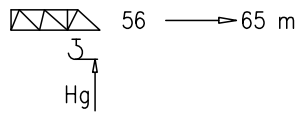

- Hg=Ht-1 m
- Hg=Ht-1.8 m

14	BCF052	2/4 M45
13	BAF052	2/4 M42
12	BPF117	4/4 M45-45
11	BNF117	4/4 M45-42
10	BOF117	4/4
9	BOF039	4/4
8	BO039	2/2
7	STR039	2/2
6	SBR117	4/2
5	SBR039	4/2
4	SB117	4/2
3	SB039	4/2
2	ST117	2/2
1	ST039	2/2

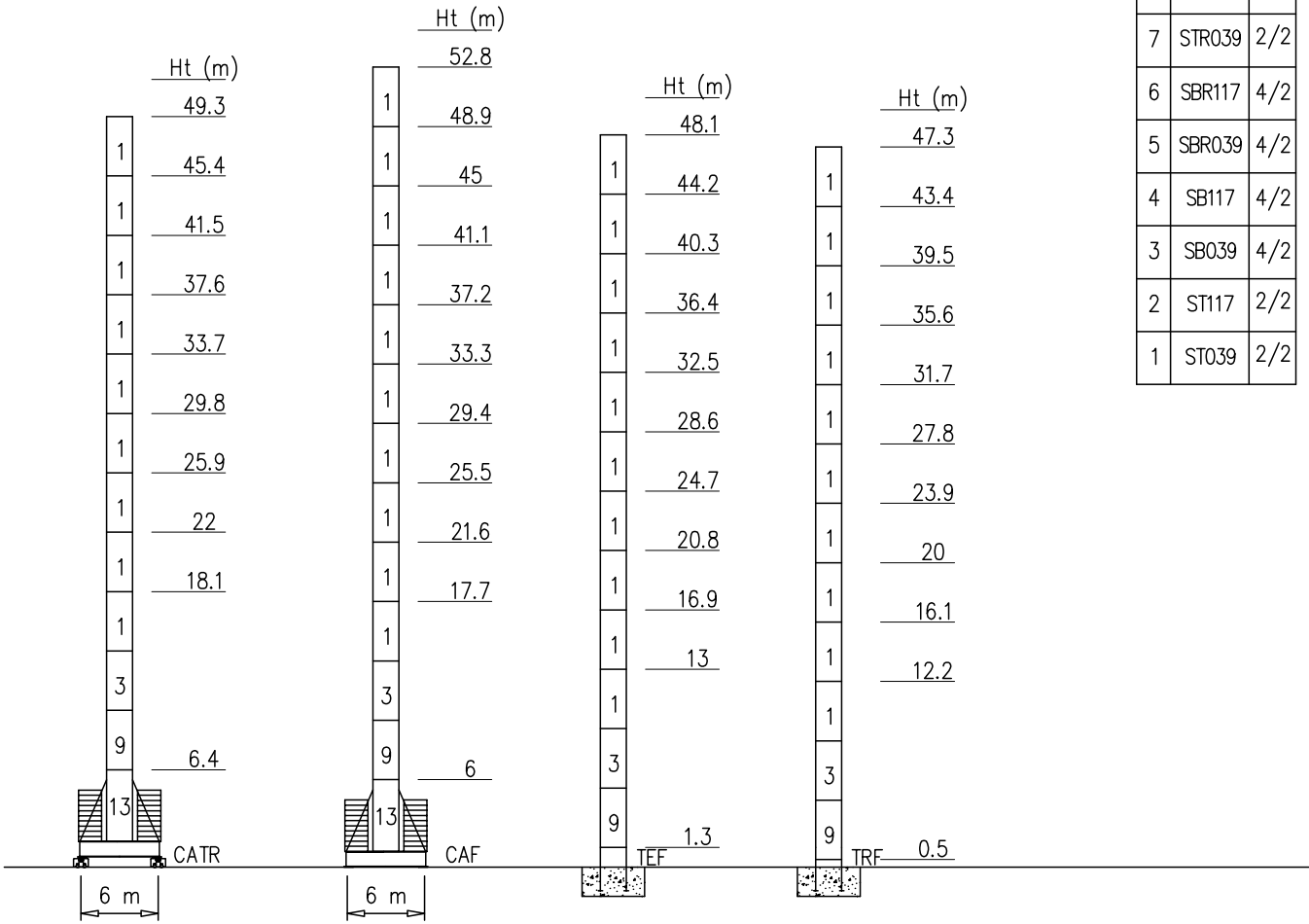

Peso zavorra – Ballast weight – Poids du lest – Ballastgewicht – Peso de lastre

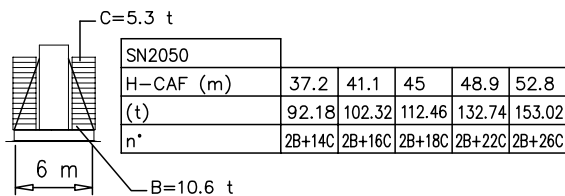
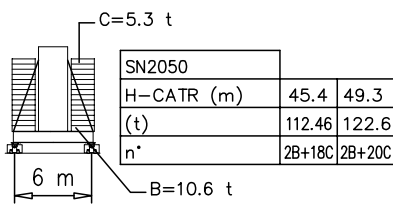

Curve di carico – Courbes de charges – Load diagrams – LastKurven – Curvas de cargas

Pmax 4000 kg

	25560 kg		3.5	26.3	34	36	38	40	42	44	46	48	50	52	54	56	58	60	62	65	m
			4000	4000	3360	3190	2940	2770	2490	2350	2220	2110	1950	1850	1760	1650	1570	1500	1300	1000	kg
	25560 kg		3.5	29.2	34	36	38	40	42	44	46	48	50	52	54	56	58	60	63	m	
			4000	4000	3360	3190	2940	2770	2490	2350	2220	2110	1950	1850	1760	1650	1570	1500	1300	kg	
	25560 kg		3.5	32.6	34	36	38	40	42	44	46	48	50	52	54	56	58	60	m		
			4000	4000	3480	3250	3050	2860	2700	2550	2410	2280	2170	2060	1960	1870	1780	1700	kg		
	25560 kg		3.5		33.8	36	38	40	42	44	46	48	50	52	54	56	m				
			4000		4000	3730	3510	3300	3030	2870	2670	2540	2400	2300	2130	2000	kg				

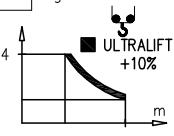





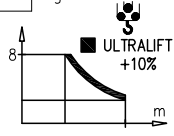

Pmax 8000/4000 kg

	25560 kg		3.5	14.9	20	24	28	30	34	36	38	40	42	44	46	48	50	52	54	56	58	60	62	65	m
			8000	8000	6360	5190	4360	4000	3360	3190	2940	2770	2490	2350	2220	2110	1950	1850	1760	1650	1570	1500	1300	1000	kg
	25560 kg		3.5	16.6	20	24	28	30	34	36	38	40	42	44	46	48	50	52	54	56	58	60	63	m	
			8000	8000	6360	5190	4360	4000	3360	3190	2940	2770	2490	2350	2220	2110	1950	1850	1760	1650	1570	1500	1300	kg	
	25560 kg		3.5	18.4	20	24	28	30	34	36	38	40	42	44	46	48	50	52	54	56	58	60	m		
			8000	8000	6360	5190	4360	4000	3480	3250	3050	2860	2700	2550	2410	2280	2170	2060	1960	1870	1780	1700	kg		
	25560 kg		3.5	19.1	20	24	28	30	34	36	38	40	42	44	46	48	50	52	54	56	m				
			8000	8000	7500	6150	5190	4810	4000	3730	3510	3300	3030	2870	2670	2540	2400	2300	2130	2000	kg				

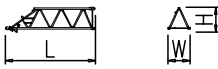
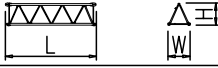

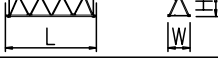
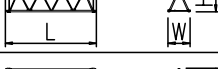



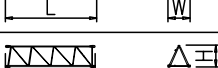
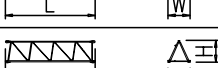
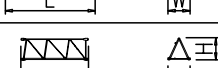
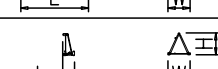
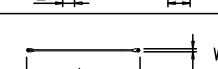
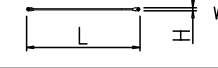
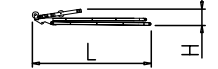
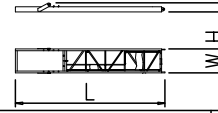
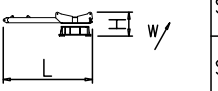
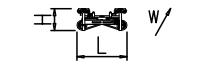
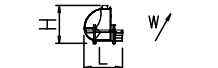



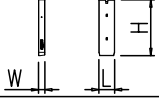



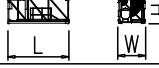

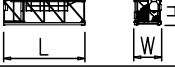



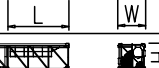
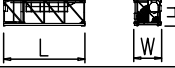
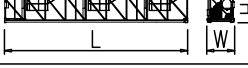

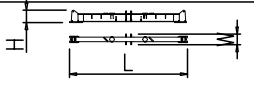
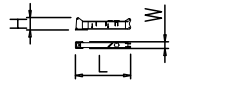

PESI E INGOMBRI – PACKING LIST – LISTE DE COLISAGE – GEWICHT UND ABMESSUNGEN

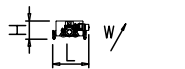
Denominazione Description	Disegno Draw	Pezzi Pieces	Dimensioni-Dimensions (mm)			Peso-Weight (kg)		
			L	W	H	Unit	Total	
Elemento di braccio Jib element Elément de èche Elemento de flecha	n°1 	1	5760	1440	1600	950	–	
	n°2 	1	5820	1400	1470	750	–	
	n°3 	1	5860	1400	1470	810	–	
	n°4 	1	5860	1400	1470	730	–	
	n°5 	1	5860	1400	1470	740	–	
	n°6 	1	5850	1400	1470	700	–	
	n°7 	1	5820	1400	1470	680	–	
	n°8 	1	5820	1400	1470	740	–	
	n°9 	1	5850	1400	1450	520	–	
	n°10 	1	5740	1400	1450	410	–	
	n°11 	1	5770	1400	1450	330	–	
	n°12 	1	4350	1400	1450	320	–	
	Punta 	1	800	1400	1400	170	–	
Tirante completo Complete tie rod Tirant complète Tirante completo		12	6500	200	200	240	3540	
Cuspide Cusp Pointre Cùspide		1	8300	1500	1000	2700	–	
Contorbraccio completo Complete counterjib Contreflèche complète Contraflecha completa		1	9300	1650	600	2000	–	
Gruppo girevole Slewing group Table tournante Grupo giratorio		SK1700	1	5100	1810	1400	6000	–
		SN2050	1	5100	1810	1400	6300	–
Carrello Trolley Chariot Carretilla		1	1900	1620	1000	400	–	
Ballatoio con cabina Access balcony with cabin Porte cabine Balcòn corrido con cabina		1	2500	2150	2450	1000	–	

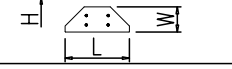
PESI E INGOMBRI – PACKING LIST – LISTE DE COLISAGE – GEWICHT UND ABMESSUNGEN

Denominazione Description	Disegno Draw	Pezzi Pieces	Dimensioni-Dimensions (mm)			Peso-Weight (kg)		
			L	W	H	Unit	Total	
Blocchi contrappeso Counterweight block Contre-poids Bloques de contrapeso	VX28 	9	1100	280	3700	2840	25600	
Elemento di torre Mast element Elément de mât Elemento de torre	ST039 	SK1700	–	3900	1785	1785	1750	–
	STR039 	SN2050	–	3900	2110	2110	2320	–
	ST052 	SK1700	–	5200	1785	1785	2250	–
		SN2050	–	5200	2110	2110	2850	–
	ST117 	SK1700	–	11700	1785	1785	4690	–
		SN2050	–	11700	2110	2110	5790	–
	SB039 	SK1700	–	3900	1785	1785	2100	–
	SB039 	SN2050	–	3900	2110	2110	2710	–
	SB052 	SK1700	–	5200	1785	1785	2600	–
		SN2050	–	5200	2110	2110	3350	–
	SB117 	SK1700	–	11700	1785	1785	4830	–
	SBR117 	SN2050	–	11700	2110	2110	7000	–
BOF039 	SK1700	–	3900	1785	1785	2450	–	
B0039 	SN2050	–	3900	2110	2110	3370	–	
BOF052 	SK1700	–	5200	1785	1785	3390	–	
	SN2050	–	5200	2110	2110	3880	–	
BOF117 BNF117 BPF117 	SK1700	–	11700	1785	1785	6920	–	
	SN2050	–	11700	2110	2110	8180	–	
Elemento di base Base element Mat de base Elemento de base	BAF052 	SK1700	1	5200	2060	2060	3650	–
	BCF052 	SN2050	1	5200	2260	2260	4040	–
Carro di base Base carriage Chassis de base Cruceta de base		4.5x4.5	1	6670	500	1260	3180	3180
		5x5	1	7550	670	780	2300	2300
		6x6	1	8870	670	780	2500	2500
		4.5x4.5	2	3100	500	1260	1400	2800
		5x5	2	3530	420	780	1060	2120
		6x6	2	4320	420	780	1200	2400
Puntoni di base Rafter Jambes de force Cabrios de base		5x5	4	4250	240	300	280	1120
		6x6	4	4560	420	300	420	1680
Elemento a perdere Disposable frame Chassis a perdre Bastidor desechable		SK1700	1	1840	1910	1910	1430	–
		SN2050	1	2600	2260	2260	2030	–
Elemento recuperabile Recoverable frame Chassis récupérable Bastidor recuperable		SK1700	1	1300	2170	2170	1720	–
		SN2050	1	1300	2620	2620	1860	–
Bogie di traslazione Driven bogie Boggie motorisée Balancin de traslaciòn			4	1160	700	600	700	2800
Blocco zavorra di base Base ballast block Lest de base Bloque de lastre		4.5x4.5	–	4400	1200	290	3500	–
		5x5	2	5300	1000	600	7300	14600
		6x6	2	6400	1200	600	10600	21200
		5x5	–	4100	1600	300	3500	–
6x6		–	4800	2000	300	5070	–	
Corsoio di montaggio Climbing cage Cage de montage Jaula de montaje		SK1700	1	8300	2600	2500	6000	–
		SN2050	1	8300	2900	2700	6700	–

GRU IN CAVEDIO – TELESCOPAGE SUR DALLES – CLIMBING CRANE – KLETTERKRANE IM GEBAUDE

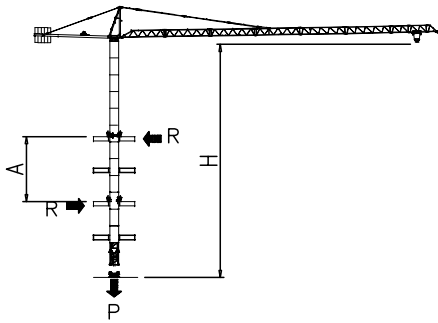

SK1700	H (m)	A (m)
	39	Min 9
Apertura passaggio gru Opening for crane passing 		Max 12

SN2050	H (m)	A (m)
	50.8	Min 9
Apertura passaggio gru Opening for crane passing 		Max 12

SOPRALZO IDRAULICO – TELESCOPABLE – EXTERNAL CLIMBING – KLETTERKRANE

FEM

	SK1700
MAX C	32.5 m
B	19.5 m
A	46.8 m

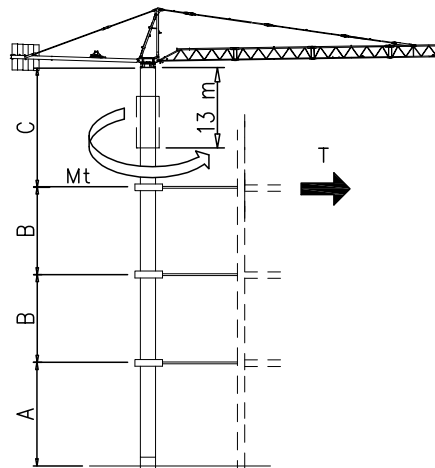

	SN2050
MAX C	36.4 m
B	23.4 m
A	46.8 m

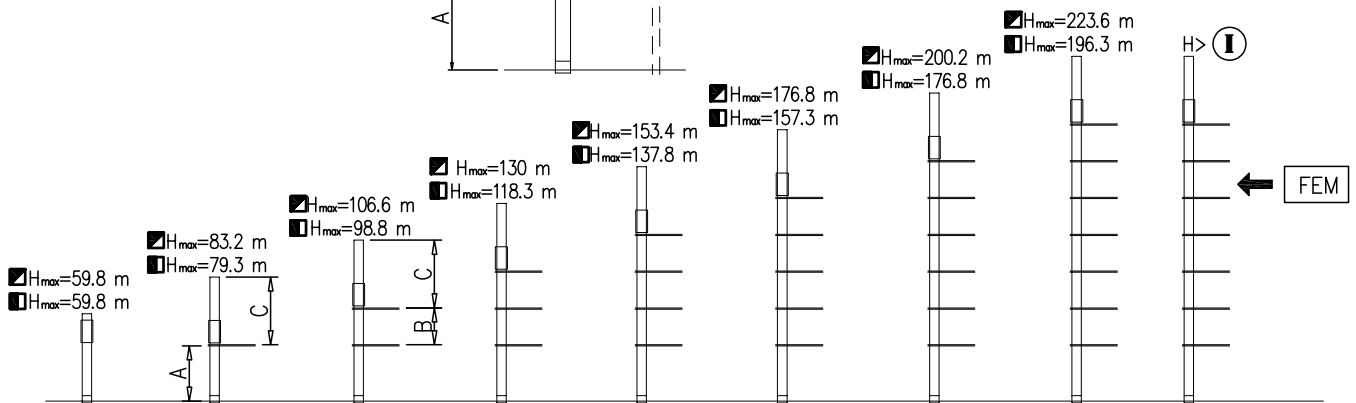

Montaggio – Montage – Erection – Montage – Montaje – Montagem

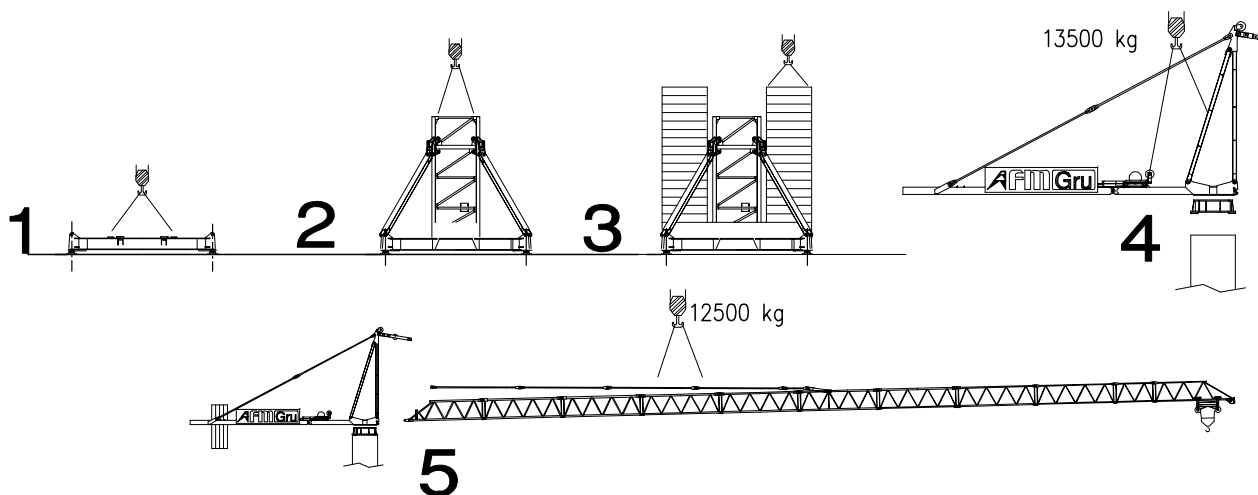

Meccanismi – Mechanisms – Mécanismes – Antriebe – Mecanismos

Sollevamento V33.60 Hoisting Levage Heben Elevaciõn Elevaçao							 	 V33.60 24 kW 40 kVA  260 m	
	m/min	2.5	15	27	43	56			71
	t	4	4	4	2.5	1.7			0.8
	m/min	1.2	7.5	13.5	21.5	28			35.5
t	8	8	8	5	3.4	1.6			
Sollevamento V45.90 Hoisting Levage Heben Elevaciõn Elevaçao							 	 V45.90 33 kW 58 kVA  340 m 700 m (L)	
	m/min	4	18	36	56	74			90
	t	4	4	4	3	2			1
	m/min	2	9	18	28	37			45
t	8	8	8	6	4	1			
Sollevamento V50.100 Hoisting Levage Heben Elevaciõn Elevaçao							 	 V50.100 37 kW 60 kVA  270 m 500 m (L)	
	m/min	4	22	48	84	100			120
	t	4	4	4	2	1.5			0.6
	m/min	2	11	24	42	50			60
t	8	8	8	4	3	1.2			

Carrello Trolleying Distribution Katzfahren Distribuciõn Distribuiçao			0 → 85	m/min	3.6 kW	Potenza elettrica necessaria Puissance électrique nécessaire Necessary electric power Anschlusswert – Potencia
			0 → 0,9	giri/min tr/min rp/min	4.4 kW @ 1200rpm n° 2 x 2.2 kW	
					0 → 20	

Rete elettrica – Réseau – Mains supply – Netzstrom – Red – Rede electrica	400V – 50 Hz
---	--------------

Rete elettrica – Réseau – Mains supply – Netzstrom – Red – Rede electrica	400V – 50 Hz
---	--------------

FEM 1.001 2000/14/CE	
-------------------------	--